



ITALIANA VALVOLE INDUSTRIALI TORINO

Produzione e vendita apparecchiature idrauliche e industriali

Valvola a farfalla
doppio eccentrico tenuta bidirezionale

butterfly valve
double eccentric bidirectional seat

PN: 10
DN: 150-2000

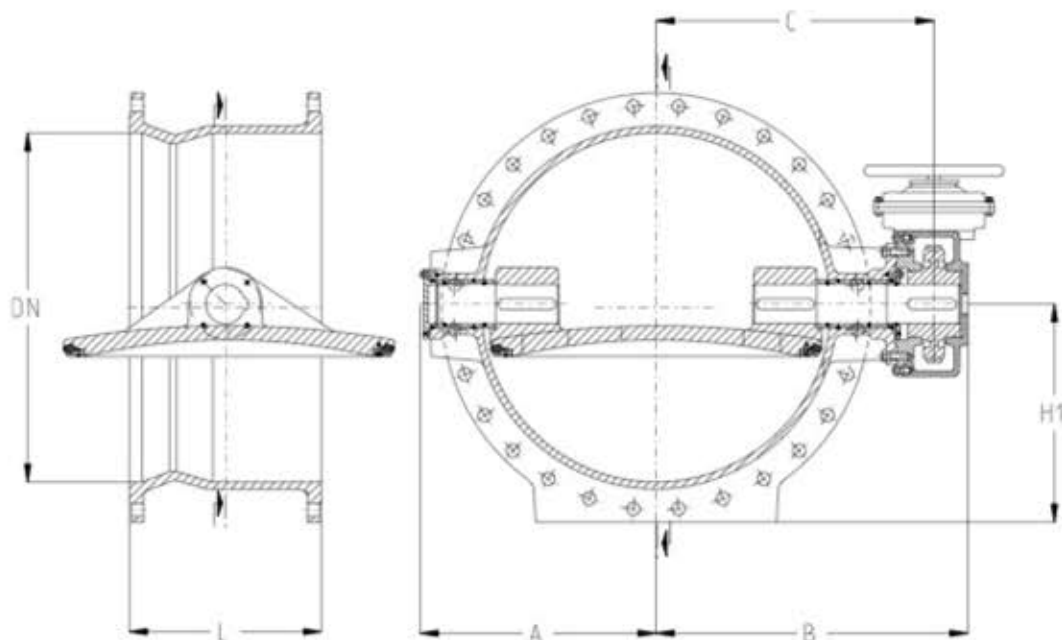

TENUTA AUTOMATICA
SELF RETAINING

DIMENSIONI DI INGOMBRO / DIMENSIONS

DN	ISO 5752 S 14	BS 5155 Scart. Ridotto / Reduced L	PN10				PESO /WEIGHT Kg
	L	L	A	B	C	H1	
150	210	140	190	255	190	145	41
200	230	152	195	290	255	170	67
250	250	165	220	350	300	200	85
300	270	178	290	405	350	230	120
350	290	190	280	415	360	255	140
400	310	216	310	430	375	285	145
450	330	222	390	525	470	310	185
500	350	229	380	500	445	335	200
600	390	267	440	585	515	390	500
700	430	292	580	810	700	450	630
800	470	318	650	885	775	510	750
900	510	330	695	890	780	560	1030
1000	550	410	760	1035	885	615	1600
1100	590	440	890	1230	1080	680	1800
1200	630	470	890	1150	1115	730	2000
1300	670	500	1035	1305	1155	780	2490
1400	710	530	1040	1405	1230	840	2980
1500	750	530	1130	1430	1255	910	3500
1600	790	600	1185	1500	1325	960	4000
1800	870	670	1295	1730	1515	1060	5400
2000	950	760	1390	1835	1620	1165	8000