



ITALIANA VALVOLE INDUSTRIALI TORINO

Produzione e vendita apparecchiature idrauliche e industriali

Valvola a farfalla
doppio eccentrico tenuta bidirezionale

butterfly valve
double eccentric bidirectional seat

PN: 25
DN: 150-2000

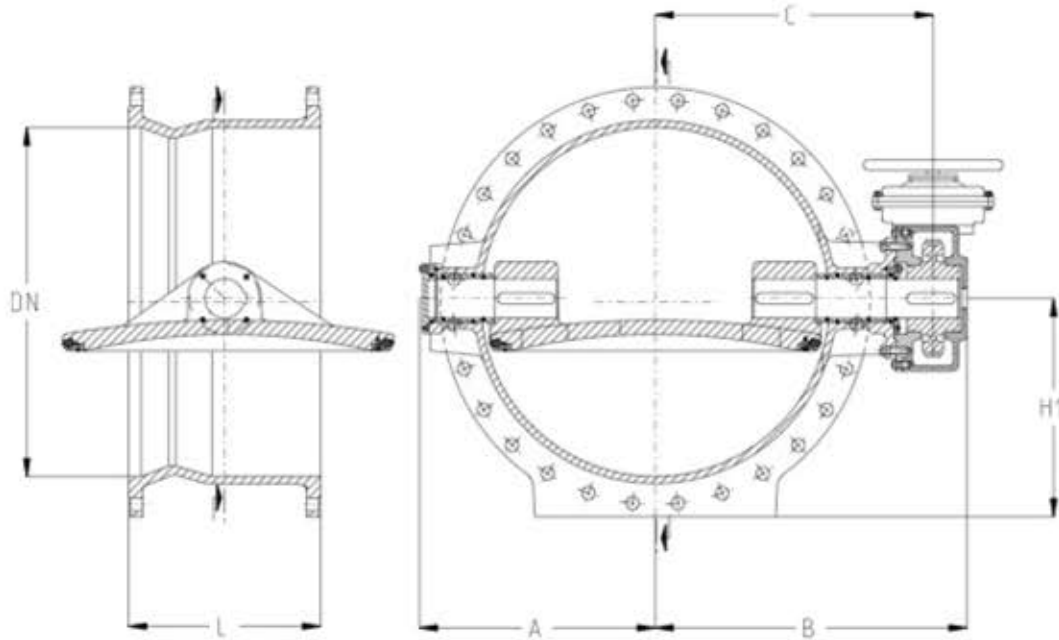

TENUTA AUTOMATICA
SELF RETAINING

DIMENSIONI DI INGOMBRO / DIMENSIONS

DN	ISO 5752 S 14	BS 5155 Scart. Ridotto / Reduced L	PN25				PESO / WEIGHT Kg
	L	L	A	B	C	H1	
150	210	140	190	255	190	145	42
200	230	152	195	290	255	170	70
250	250	165	220	350	300	200	90
300	270	178	290	405	350	230	132
350	290	190	280	415	360	255	208
400	310	216	310	430	375	285	275
450	330	222	390	525	470	310	290
500	350	229	380	500	445	335	325
600	390	267	440	585	515	390	660
700	430	292	580	810	700	450	740
800	470	318	650	885	775	510	930
900	510	330	695	890	780	560	1405
1000	550	410	760	1035	885	615	2200
1100	590	440	890	1230	1080	680	2600
1200	630	470	890	1150	1115	730	3250
1300	670	500	1035	1305	1155	780	4000
1400	710	530	1040	1405	1230	840	4350
1500	750	530	1130	1430	1255	910	5180
1600	790	600	1185	1500	1325	960	6200
1800	870	670	1295	1730	1515	1060	7300
2000	950	760	1390	1835	1620	1165	9000